



the essential guide to reinforcing concrete

■ **Bar & fabric products**

■ **Spacers & accessories**

■ **Slab products**

■ **Formwork**

■ **Weldmesh and gabions**

2007

BRC

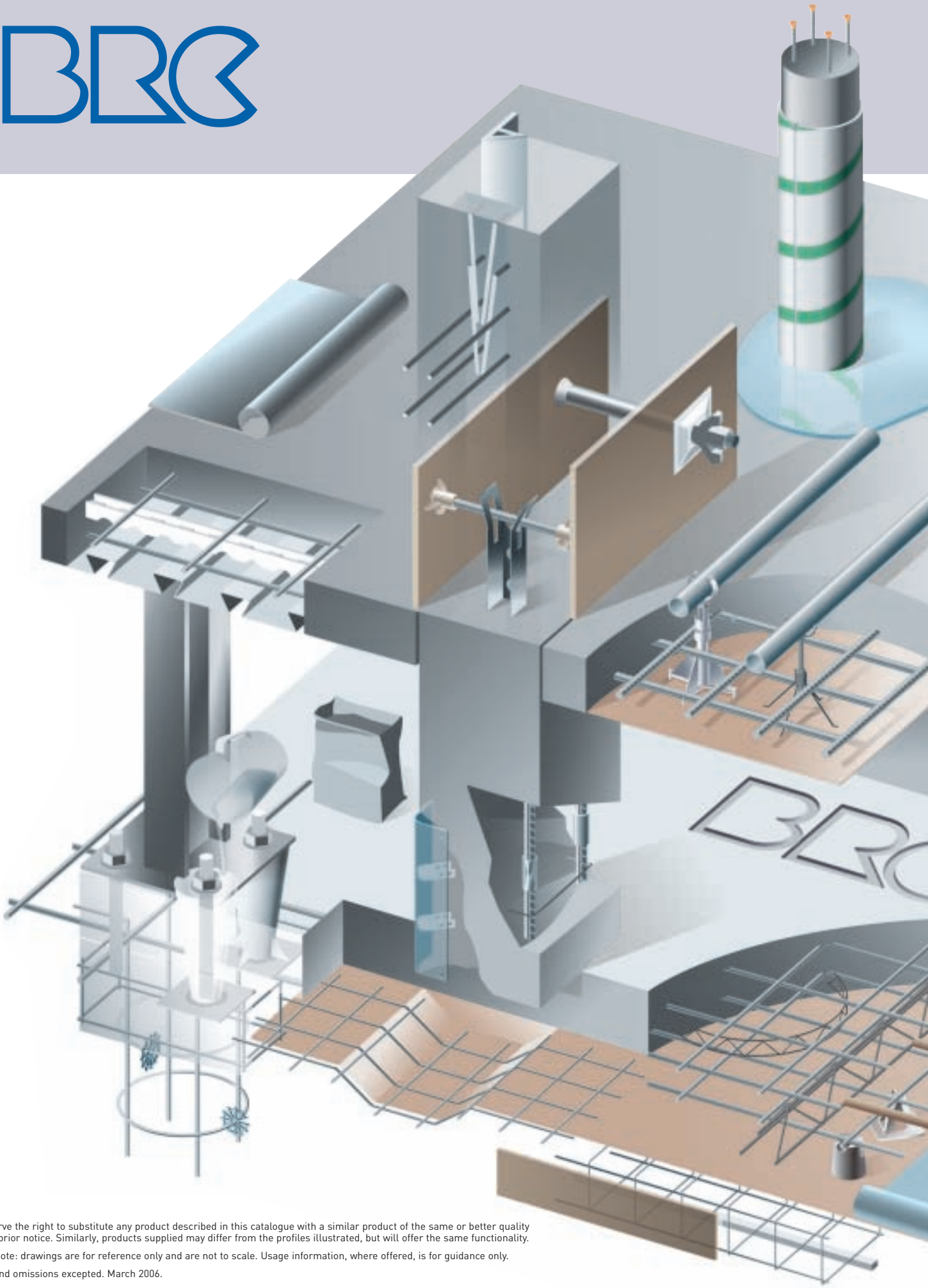

We reserve the right to substitute any product described in this catalogue with a similar product of the same or better quality without prior notice. Similarly, products supplied may differ from the profiles illustrated, but will offer the same functionality. Please note: drawings are for reference only and are not to scale. Usage information, where offered, is for guidance only. Errors and omissions excepted. March 2006.

the essential guide to reinforcing concrete

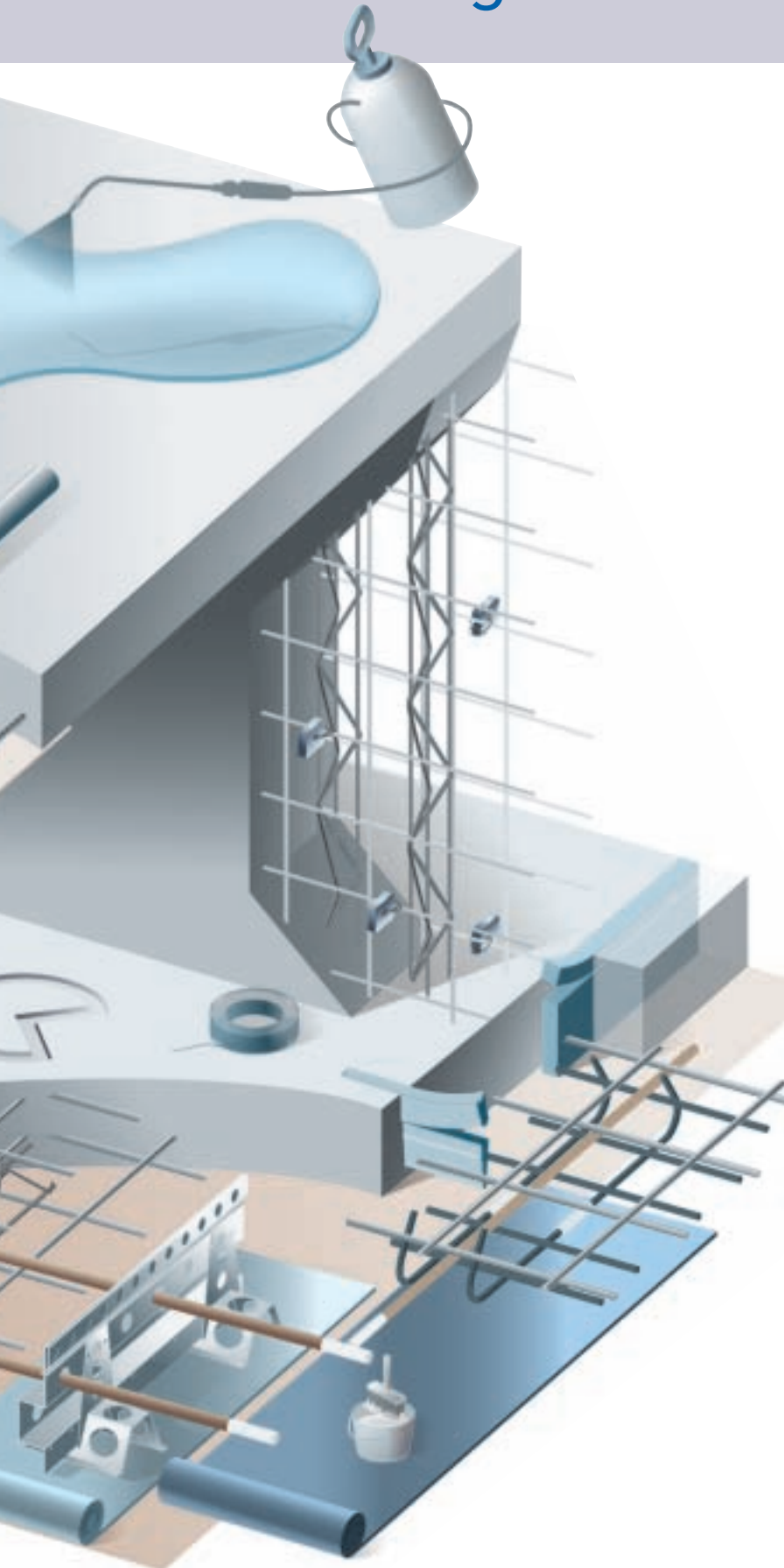

**Bar & fabric
products**
p5-15



**Spacers &
accessories**
p16-19



Slab products
p20-26



Formwork
p27-29

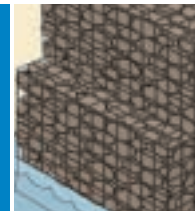

**Weldmesh
& gabions**
p30-31

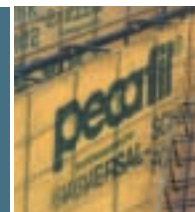

**Other BRC
companies**
p32-34

Customer service, quality systems, technical support, competitive prices

BRC is the UK's largest supplier of steel reinforcement and associated products for concrete. With a network of strategically placed manufacturing locations, we are able to meet all your requirements regardless of the size of project.

We have tried to make this catalogue as comprehensive as possible, but cannot include every single item from our huge product range. So, if you do not see the product you are looking for, please give us a call. You will find contact numbers for all our sales offices at the bottom of every page.

Contract management

A nationwide network of dedicated, professional teams monitor the flow of information from site call-off, through manufacturing to point of delivery, to ensure that your requirements are fully met.



- **Quality Management systems to BS EN ISO 9001:2000**
- **National coverage**
- **CARES approved at all locations**
- **After sales support**
- **Dedicated contract management**
- **Technical support**
- **Capacity to handle all sizes of project**
- **Competitive pricing**
- **Commitment to total customer service**

Sales offices: Midlands 01623 555111
North 01226 730330
North East 01325 381166

North West 0161 620 1001
South 01794 521158
South East 020 7474 1800

South West 01752 894660
Scotland 01698 732343
Wales & West 01633 244002

DYNA Quell Waterstop

DYNA Quell is a high swelling material used for effective sealing of joints in concrete construction. It is produced from a combination of Bentonite and Butyl rubber. This material will expand on contact with water to seal the gaps and pores in a concrete joint.

After expanding the material retains its elasticity so that the seal will not be affected by any subsequent movement of the structure.

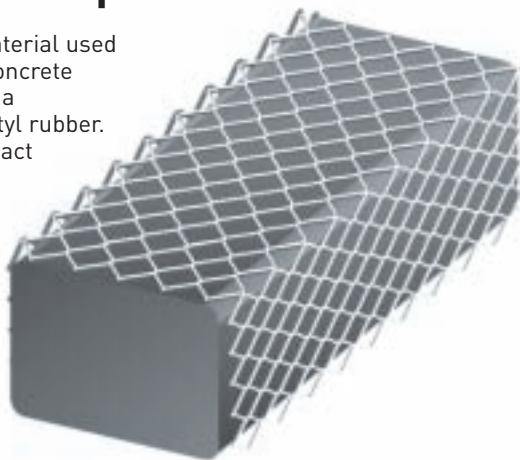

DYNA QUELL WATERSTOP

GROUP CII52

Ref.	Dim. mm	Roll Size m	Pack size
DBWATERSTOP20/25	20x25	5	8
FIXINGSTRIP1	1m		
FIXINGNAIL			100

Polythene and joint tape

The products are available in thicknesses of

- 250 microns (1000 Gauge).
- 300 microns (1200 Gauge).
- 500 microns (2000 Gauge).

300 micron polythene is also available as a centrefold.

Standard polythene is folded twice and supplied as a 1m wide roll. Centrefold polythene is folded once and supplied as a 2m wide roll.

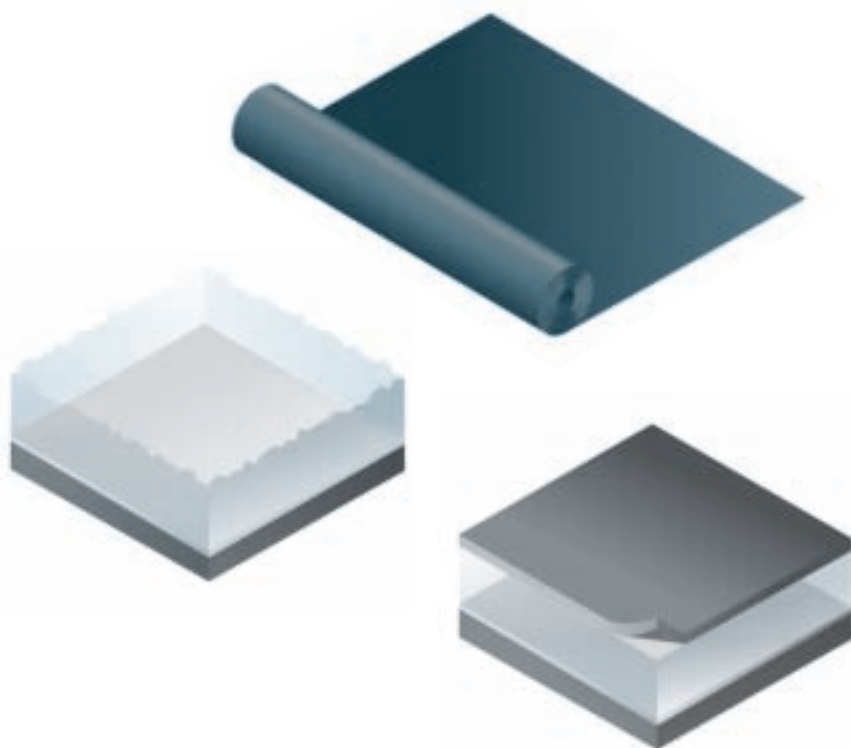

BBA GRADE POLYTHENE

GROUP CG603

Ref.	Thickness µm	Roll Width m	Roll Length m
DP1000	250	4	25
DP1200	300	4	25

PIFA GRADE POLYTHENE

GROUP CG603

Ref.	Thickness µm	Roll Width m	Roll Length m
PDP1000	250	4	25
PDP1200	300	4	25
PDP2000	500	4	12.5

TEMPORARY PROTECTIVE SHEETING

GROUP CG603

Ref.	Roll Width m	Roll Length m
TPSM (medium duty)	4	50
TPSH (heavy duty)	4	25

JOINTING TAPE

GROUP CCCB9

Ref.	Roll Size	Pack Qty.
SST (single sided)	50mm x 66m	10
DST (double sided)	50mm x 66m	10

Gas protection membranes

BRC offer a range of gas barriers to provide protection against methane or radon gas. Fully certificated, the range briefly comprises:

Radon barrier

Manufactured from LDPE, reinforced with a strong multifilament yarn. Typical weight is 370g/m².

Methane barrier

Manufactured from LDPE, reinforced with a strong multifilament yarn and aluminium foil. Typical weight is 420g/m².

Accessories

Also available is a full range of ducts, vents and sumps.

Service

Non standard panels can be produced to suit an individual layout. This minimises cutting and waste, as well as simplifying the laying process and ensuring that a full seal is provided.

We can provide design assistance and layout drawings.

A supply and fix service can also be made available.

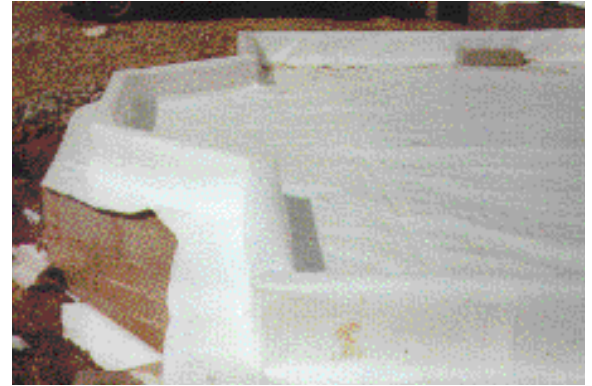

Premseal

Waterproof membranes

Premseal waterproof membranes combine the very best in modern polymer laminates with traditional bitumen and polymer adhesives to form extremely tough, hard-wearing waterproof membranes for even the most stringent applications.

All Premseal membranes are designed to have excellent situation-tolerant installation properties. Specialist membranes are available to give protection against landfill gases such as methane, naturally occurring radioactive radon and solar radiation.

Pipe through slab

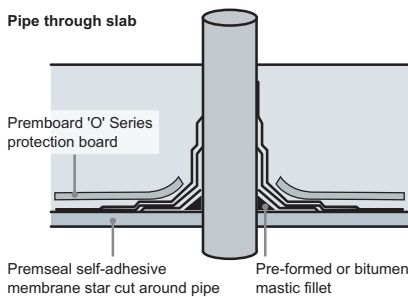

Internal corner

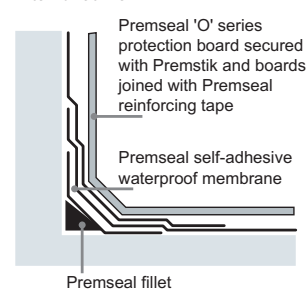

Concrete parapet

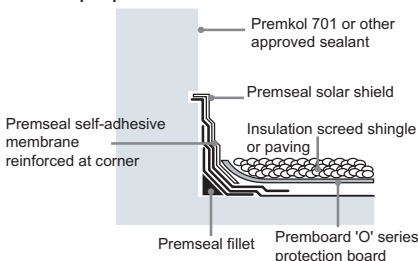

External corner

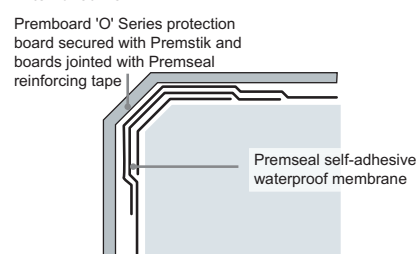

Dowel bars

Sawn end plain round

A full range of sawn end, plain round dowel bars for use in movement joints.

High yield ribbed tie-bars

A full range of high yield ribbed tie-bars for use in tied joints where movement is to be restricted.

Stainless steel dowels

Supplied to order.



DOWEL BARS GROUP CGG07	
Ref.	Dia. mm
R10	10
R12	12
R16	16
R20	20
R25	25

TIE BARS GROUP CGG07	
Ref.	Dia. mm
T10	10
T12	12
T16	16
T20	20
T25	25

Dowel bar sleeves

Plastic debonding sleeves for use in dowelled movement joints.



DOWEL BAR SLEEVES - GROUP CMM01			
Ref.	Bar Dia. mm	Sleeve Length mm	Pack Qty.
DB12/450	12	450	100
DB16/200	16	200	100
DB16/450	16	450	100

DOWEL BAR SLEEVES - continued			
Ref.	Bar Dia. mm	Sleeve Length mm	Pack Qty.
DB20/300	20	300	100
DB25/300	25	300	100
DB25/375	25	375	100

Dowel bar debonder

A bituminous based compound to allow dowel bars to completely break bond with concrete. Complies with clause 1011 DOT specification for highways work.

Coverage

1.8 - 3.6m² per litre.



DOWEL BAR DEBONDER GROUP CCCB8	
Ref.	Pack Size
DB005	5L
DB025	25L

Expansion dowel caps

Rigid PVC caps with compressible filler (25mm) to allow for expansion.



EXPANSION DOWEL CAPS GROUP CGG05				
Ref.	Bar Dia. mm	Cap Length mm	Pack Qty.	
D12	12	100	100	
D16	16	100	100	
D20	20	100	100	
D25	25	100	100	
D32	32	100	100	
D40	40	100	100	

Dowel bar cradles

Contraction joint cradles

Height is to the underside of the dowel. Supplied by the half cage.

Sleeves

For use with contraction joint cradles. Usage: 5 sleeves per linear metre of joint.

Expansion joint cradles

Height is to the underside of the dowel. Supplied by the half cage.

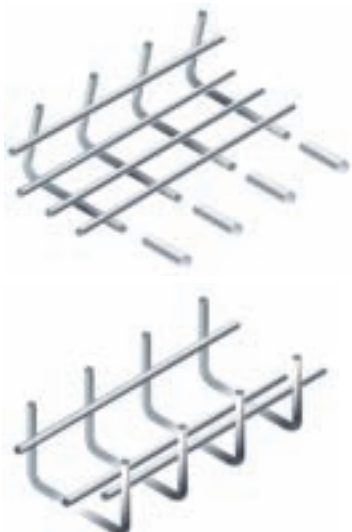

CONTRACTION JOINT CRADLES GROUP CSS60			
Ref.	Height mm	Slab Depth Range mm	Length mm
CJC75	75	150-180	2000
CJC95	95	190-230	2000
CJC125	125	240-300	2000

EXPANSION JOINT CRADLES GROUP CSS60			
Ref.	Height mm	Slab Depth Range mm	Length mm
EJC65	65	150-180	2000
EJC90	90	190-230	2000
EJC115	115	240-300	2000

Crack inducers

Top crack inducer (two-part)

Rigid PVC extrusions for use in induced joints. Total depth of crack inducer to be 1/4 to 1/3 of slab depth.



Bottom crack inducer

Rigid PVC extrusions for use in induced joints. Total depth of crack inducer to be 1/4 to 1/3 of slab depth.

TOP CRACK INDUCER GROUP CMM07

Ref.	Top Section Width/Depth mm	Bottom Section Depth mm	Section Depth mm
BF10/50/25	10/25	25	50
BF10/75/25	10/25	50	75

BOTTOM CRACK INDUCER GROUP CMM05

Ref.	Section	Depth mm
CY40	Y	40
CY50	Y	50
CY75	Y	75

Miothene joint filler

Closed cell polyethylene foam strip 35kg/m³

Perforated for easy removal of top section. Standard range supplied in 2m strips.

Also available in sheets or cut to size in 10mm, 12mm, 15mm, 20mm and 25mm thicknesses.

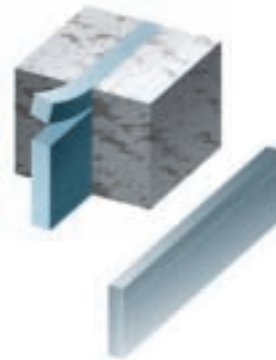

MIOTHENE JOINT FILLER GROUP CMM20

Ref.	Width mm	Thickness mm	Perforated mm from edge
S100/10/10	100	10	10
S140/10/10	140	10	10
S150/12/12	150	12	12
S150/20/20	150	20	20
S175/12/12	175	12	12
S175/20/20	175	20	20
S200/12/12	200	12	12
S200/20/20	200	20	20

Frost/curing blankets

Closed cell polyethylene blanket

Effective as frost protection in winter and to aid curing during summer.

Air bubble blankets and hessian blankets also available.



FROST/CURING BLANKET GROUP CMM10

Ref.	Description
FB75X2/10	75 x 2m blanket, 10mm thick

Concrete screed rails

Concrete screed rail for accurate floor levels without the need to strike traditional road forms.



CONCRETE SCREED RAILS GROUP CPP11

Ref.	Height mm	Length m	Rails Per Bundle
BR50	50	3	104
BR100	100	3	48
BR125	125	3	33
BR150	150	3	27

Screed chairs

Plastic screed chairs are fully adjustable and ideal for lightweight applications. Use with a 50mm diameter tube. Shaft is supplied in 2m lengths to be cut on site.

Metal screed chairs are fully adjustable and supplied in two parts. Height is adjusted using thread.



PLASTIC SCREED CHAIRS GROUP CGG01

Ref.	Description
SCS	Saddle
SCC	Collar
SCB	Base
T22	22mm Tubing for Shaft

METAL SCREED CHAIRS GROUP CGG01

Ref.	Height Range mm
MSC115-150	115-150
MSC145-205	145-205
MSC195-310	195-310
MSC285-405	285-405

PermaSteel

PermaSteel is a low cost 'leave-in-place', light duty application screed rail that takes the concept of 'leave-in-place' formwork onto the next stage. Using Permaban's experience in constructing floors and formwork design, other 'all steel' formwork systems were examined in depth and in every case design or installation faults were evident in some way. Permaban addressed these shortcomings with the development of PermaSteel.

In addition PermaSteel provides some arris support, accommodates dowel bars, acts as a crack inducer and can be supplied with a sealant void former. Permasteel rails are easy to handle and transport as the weight is low and they are delivered in bundles that can be stacked.

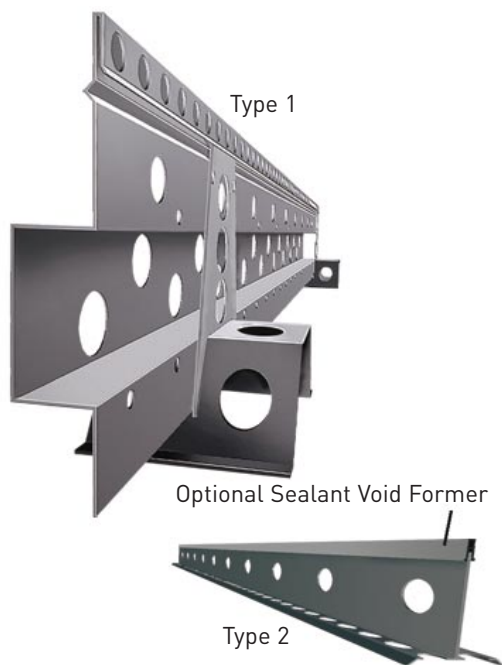

PERMASTEEL ALL STEEL SCREED RAILS		
GROUP CPP99		
Ref.	Height mm	Length m
Type 1		
MSR115mmx3m	115	3
MSR155mmx3m	155	3
PERMASTEEL/LFEET	115/155 extra feet	
*Type 1 comes with 3 feet. If a Bunyan striker is used then employ at least 4 feet per 115mm rail and 5 for the 155mm.		
Type 2		
MSR40mmx3m	40	3
MSR70mmx3m	70	3
SSVF	Void former	3

For heavy duty applications, please use the AlphaJoint range of products.

BetaJoint

An easily installed, adjustable 'leave-in-place' formwork system for light to medium duty applications with bolt-on 'leave-in-place' feet, or use Permaban AlphaFix removable fixing system to provide 'Micrometer' adjustment for superflat floors.

BetaStrip 2mm wide or BetaTop 12mm wide screed rail for tied joints or BetaJoint for contraction joints.

Available for 100mm to 225mm deep slabs and easily adjustable to level. Load transfer by 6mm Diamond Dowels, round or square dowel, or tie bar.

Special Beta-products available for slab depths up to 400mm deep.

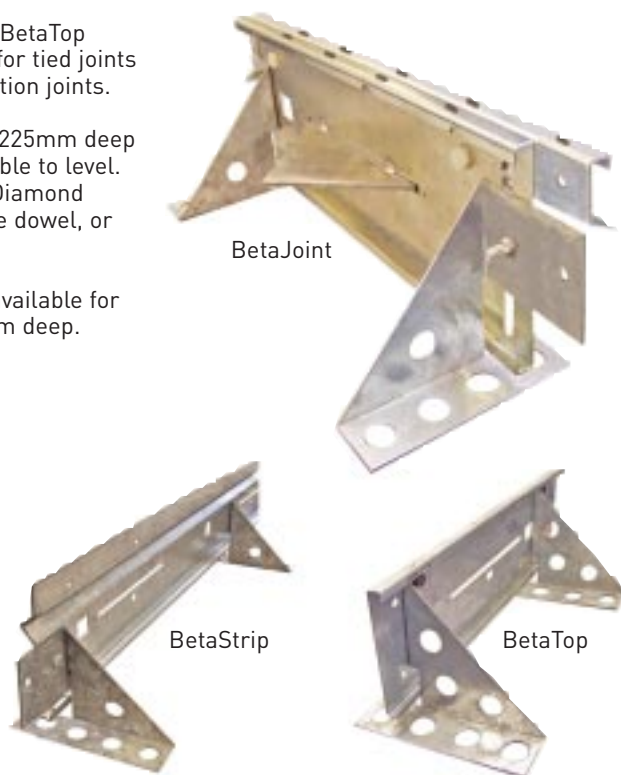

BETAJOINT		
GROUP CPP99		
Ref.	Height mm	Length m
B-JT100	100	3
B-JT125	125	3
B-JT150	150	3
B-JT175	175	3
B-JT200	200	3

BETASTRIP		
GROUP CPP99		
Ref.	Height mm	Length m
BDP-SP/SD-100	100	3
BDP-SP/SD-125	125	3
BDP-SP/SD-150	150	3
BDP-SP/SD-175	175	3
BDP-SP/SD-200	200	3

BETATOP		
GROUP CPP99		
Ref.	Height mm	Length m
BDP-TP/SD-100	100	3
BDP-TP/SD-125	125	3
BDP-TP/SD-150	150	3
BDP-TP/SD-175	175	3
BDP-TP/SD-200	200	3

AlphaJoint

Permaban AlphaJoint gives concrete floors enhanced performance from free contraction joints. It incorporates patented systems of load transfer across joints, which enhance the loading value of the concrete floor. AlphaJoint satisfies the requirements in Concrete Society TR34 and BS8204-2: 1999 for load transfer and aris protection in heavy duty concrete floor slabs.

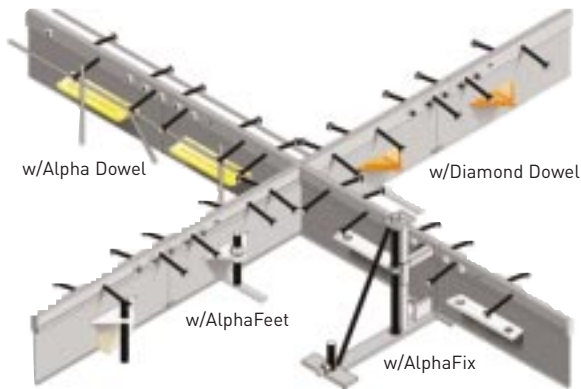

ALPHAJOINT GROUP CPP21		
Ref.	Height mm	Length m
DD6-120/140/150/175	150-200	3
DD6-225	201-250	3
AD10-120/140/150/175	150-200	3
AD10-7-225	201-250	3
AD10-7-250/275	251-300	3

Dowel systems

Permaban Dowel Systems provide superior load transfer across the joint compared to traditional round dowels. These innovations spread stress over the full width of the dowel.

Permaban dowels allow sub base preparation right up to the slab edge.

Permaban dowel systems eliminate vertical joint movement while allowing two-way lateral joint movement between adjacent bays of the concrete slab.

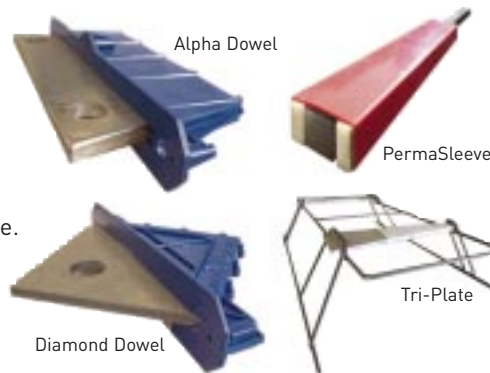

DOWEL SYSTEMS GROUP C6G07		
AD10-CS-NT	Alpha Dowel	
DD6-CS-NT	Diamond Dowel	
TR10 or 6	Tri-Plate	

PERMASLEEVE GROUP C6G07	
Square dowel bar	
GROUP CMM01	
Sleeve for square dowel bar	

Manhole surrounds

This new product allows virtually any manhole to be isolated and finished with far greater ease than before. It reduces the need to finish the awkward detailing around these objects during the middle of a large flood pour of concrete.

Each surround has jacking studs to give accurate adjustment to height and level as well as effective load transfer features using Permaban Diamond Dowels.



MANHOLE SURROUNDS GROUP CPP40		
Ref.	Height mm	Length m
MHS-150-1000	150	1 x 1
MHS-150-1500	150	1.5 x 1.5
MHS-150-2000	150	2 x 2
MHS-150-3000	150	1.5 x 3
MHS-175-1000	175	1 x 1
MHS-175-1500	175	1.5 x 1.5
MHS-175-2000	175	2 x 2
MHS-175-3000	175	1.5 x 3
MHS-200-1000	200	1 x 1
MHS-200-1500	200	1.5 x 1.5
MHS-200-2000	200	2 x 2
MHS-200-3000	200	1.5 x 3

Other products

- Composite flooring systems
- Pumpable flooring systems
- Terrazzo styling techniques
- Dry-Shake floor toppings
- PermaSeal floor sealant systems
- PermaFlex joint sealant systems

PERMABAN
Better. Solutions. for. Better. Floors.

www.permaban.com



Sales offices: Midlands 01623 555111
North 01226 730330
North East 01325 381166

North West 0161 620 1001
South 01794 521158
South East 020 7474 1800

South West 01752 894660
Scotland 01698 732343
Wales & West 01633 244002

Release

Mould release oil

A high quality mould oil for general site and precast yard use that achieves a top quality concrete finish in most situations.

BCA category 2.

UKWFBS listed.

Spray or brush applied. Coverage: 20-30m² per litre.

Chemical release agent

Specially blended reactive oils which give a high quality finish with most formwork types.

BCA category 5.

UKWFBS listed.

Spray applied. Coverage: 30-50m² per litre.

MOULD RELEASE OIL

GROUP CCCB1

Ref.	Size
MRO005	5L
MRO025	25L
MRO205	210L

CHEMICAL RELEASE AGENT

GROUP CCCB1

Ref.	Size
CRA25	25L
CRA205	210L

Curing

Curing compound – silicate based

An aqueous solution of metallic silicates as a general curing aid. Also available tinted.

UKWFBS listed.

Spray applied. Coverage: 5.5-6m² per litre.

Curing compound – resin based

Formulated with inert hydrocarbon resins to give excellent film and moisture retention.

90% efficiency rating.

UKWFBS listed.

Spray applied. Coverage: 5.5-6m² per litre.

Curing and sealing compound

A clear acrylic polymer resin solution for application to surfaces of freshly laid concrete to form a highly effective curing membrane and an in-depth sealer.

75% efficiency rating

Spray applied. Coverage: 6m² per litre.

CURING & SEALING COMPOUNDS

GROUP CCCB5

Ref.	Type	Size
SCA025	Silicate Based	25L
SCA205	Silicate Based	210L
CM025	Resin Based 90%	25L
CM205	Resin Based 90%	210L
CSC025	Curing & Sealing	25L
CSC205	Curing & Sealing	210L

Water-based curing products

Water-based curing products are also available. Please contact your local BRC sales office for details.

Surface hardening and dustproofing

A surface hardener for new and old concrete floors to provide dustproofing and increase durability.

Brush applied. Coverage: 6m² per litre (dependent on floor porosity).

SURFACE HARDENING

GROUP CCCB5

Ref.	Size
SH025	25L
SH200	210L

Surface retarders

To provide an exposed aggregate finish for concrete or a key for subsequent pours.

Mould face

For application to mould face prior to placing of concrete.

Brush applied. Coverage: 15-16m² per litre.

Top face

For treatment to the top face of freshly cast concrete.

Spray applied. Coverage: 5m² per litre.

SURFACE RETARDERS

GROUP CCCA4

Ref.	Type	Size
AMFS005	Mould Face Retarder	5L
AMFS025	Mould Face Retarder	25L
ATFS005	Top Face Retarder	5L
ATFS025	Top Face Retarder	25L
ATFS205	Top Face Retarder	210L

Sprayers

Plastic and metal sprayer units

SPRAYERS

GROUP CCCN7

Ref.	Type	Size
PLT1	Plastic	7L
PLT125	Plastic	12.5L
LMS07	Metal	9L
LMS11	Metal	11L

BRC **A DIVISION OF BRC Limited**

CONDITIONS OF SUPPLY

1. Interpretation

1.1 In these Conditions:

"Buyer" means the party which accepts a quotation given to it by the Seller for the sale of the Goods.

"Conditions" means the standard terms and conditions of supply set out in this document and unless the context otherwise requires includes any special terms and conditions agreed in Writing between the Buyer and the Seller.

"Contract" means the contract for the sale and purchase of the Goods.

"Goods" means the goods set out in the Quotation (including any instalment of the goods or any part of them) which the Seller is to supply in accordance with these Conditions.

"Order Confirmation" means confirmation given by the Seller to the Buyer that the Seller agrees to supply an order of the Buyer on these Conditions.

"Price" means the price of the Goods.

"Quotation" means a quotation given by the Seller to the Buyer on the basis of these Conditions.

"Seller" means BRC Limited of Edstone Hall, Wootton Waven, Solihull, B95 6DD. Registered in England No. 3721267.

"Specification" includes any plans, drawing, data, formulae, instructions or other information relating to the Goods.

"Writing" includes facsimile transmission and comparable means of communication.

1.2 Any reference in the Conditions to a statute or a provision of a statute shall be construed as a reference to that statute or provision as amended, re-enacted or extended at the relevant time.

1.2 The headings in these Conditions are for convenience only and shall not affect their interpretation.

2. Basis of Purchase

2.1 The Quotation shall constitute an invitation to treat by the Seller.

2.2 An order submitted by the Buyer shall constitute an offer by the Buyer to purchase the Goods subject to these Conditions.

2.3 No order shall be accepted or deemed to be accepted by the Seller unless and until confirmed in Writing by the Seller's authorised representative by way of Order Confirmation.

2.4 All quotations made by the Seller in respect of material ex-stock are subject to the material being in stock at the time the Buyer's order is received and the Seller accepts no liability should such material be sold before the Buyer's order is received.

2.5 The Seller shall supply and the Buyer shall acquire the Goods in accordance with the Seller's Order Confirmation subject to these Conditions, which shall govern the Contract to the exclusion of any other terms and conditions subject to which any such quotation is accepted or purported to be accepted, or any such order is made or purported to be made, by the Buyer.

2.6 No variation to these Conditions shall be binding unless agreed in Writing between the authorised representatives of the Buyer and the Seller.

2.7 The Seller's employees or agents are not authorised to make any representations concerning the Goods unless confirmed by the Seller in Writing. In entering into the Contract the Buyer acknowledges and agrees that it does not rely on any such representations which are not so confirmed.

2.8 Any advice or recommendation given by the Seller or its employees or agents to the Buyer or its employees or agents as to the storage, application or use of the Goods which is not confirmed in Writing by the Seller is followed or acted upon entirely at the Buyer's own risk, and accordingly the Seller shall not be liable for any such advice or recommendation which is not so confirmed.

2.9 Any typographical, clerical or other error or omission in any sales literature, quotation, price list, acceptance of offer, Order Confirmation, invoice or other documentation or information issued by the Seller shall be subject to correction without any liability on the part of the Seller.

2.10 The Buyer shall be responsible for the efficacy or otherwise of any information, advice or instructions regarding the Goods given by the Buyer or attached to the Goods and the Buyer shall be liable for and shall indemnify the Seller against all losses, damages, costs and expenses incurred by the Seller or awarded against the Seller in connection with or arising from such information, advice or instructions.

2.11 Where the Contract provides for testing and inspection of the goods before delivery, the Buyer may carry out testing and/or inspection of the Goods at its own expense and at the Seller's producing works within 7 days of notification by the Seller to the Buyer that the Goods are ready for delivery. The Buyer shall pay for all test pieces which comply with the Specification.

2.12 At the expiry of 7 days from the notification referred to in 2.11, the Seller shall be entitled to deliver the Goods to the Buyer as provided in these Conditions whether or not the Buyer has carried out any testing or inspection.

3. Orders and Specifications

3.1 No order submitted by the Buyer shall be deemed to be accepted by the Seller unless and until confirmed in Writing by the Seller's authorised representative by way of Order Confirmation.

3.2 The Buyer shall be responsible to the Seller for ensuring the accuracy of the terms of any order (including any applicable specification) submitted by the Buyer, and for giving the Seller any necessary information relating to the Goods within a sufficient time to enable the Seller to perform the Contract in accordance with its terms.

3.3 The quantity, quality and description of the Goods shall, subject as provided in these Conditions, be as specified in the Quotation and/or in any applicable Specification supplied by the Buyer or agreed in Writing by the Buyer.

3.4 The Seller reserves the right to make any changes in the specification of the Goods and the substances, chemicals and materials used to manufacture the Goods but any such changes shall not materially affect the quality or performance of the Goods.

3.5 The Goods shall be supplied subject to the tolerances set out in the Seller's catalogue and sales literature when the Contract is made.

3.6 If the Goods are to be manufactured or any process is to be applied to the Goods by the Seller in accordance with a specification submitted by the Buyer, the Buyer shall indemnify the Seller against all loss, damages, costs and expenses awarded against or incurred by the Seller in connection with or paid or agreed to be paid by the Seller in settlement of any claim for infringement of any patent, copyright, design, trade mark or other industrial or intellectual property rights of any other person which results from the Seller's use of the Buyer's specification.

3.7 No order which has been accepted by the Seller may be cancelled by the Buyer except with the agreement in Writing of the Seller and on the terms that the Buyer shall indemnify the Seller in full against all loss (including loss of profit), costs (including the cost of labour and materials), damages, charges and expenses incurred by the Seller as a result of cancellation.

4. Price

4.1 Subject to 4.2, the Price shall be the Seller's ruling price as at the date of delivery of the Goods. Payment shall be made in sterling unless otherwise agreed.

4.2 The Seller reserves the right, by giving notice to the Buyer at any time before delivery, to increase the Price beyond the ruling price referred to in clause 4.1 to reflect any increase in the cost to the Seller which is due to any factor beyond the control of the Seller (such as, without limitation, any foreign exchange fluctuation, introduction of the Euro, currency regulation, alteration of duties, significant increase in the costs of labour, materials and other costs of manufacture), any change in delivery dates, quantities or specifications for the Goods which is requested by the Buyer, or any delay caused by any instruction of the Buyer or failure of the Buyer to give the Seller adequate information or instructions.

4.3 Except as otherwise stated under the terms of any quotation and unless otherwise agreed in Writing between the Buyer and the Seller, the Price shall be on an ex works basis, and where the Seller agrees to deliver the Goods otherwise than at the Seller's premises, the Buyer shall be liable to pay the Seller's additional charges for transport, packaging and insurance.

4.4 The Price and any additional charges payable hereunder shall be exclusive of any applicable value added tax or other tax or duty relating to the sale or delivery of the Goods, which the Buyer shall be additionally liable to pay to the Seller.

4.5 The cost of pallets and containers unless otherwise agreed in writing between the Buyer and the Seller will be charged to the Buyer in addition to the Price.

5. Terms of Payment

5.1 Subject to any special terms agreed in Writing between the Buyer and the Seller, the Seller shall be entitled to invoice the Buyer for the Price or for any time after delivery of the Goods, unless the Goods are to be collected by the Buyer or the Buyer wrongfully fails to take delivery of the Goods, in which event the Seller shall be entitled to invoice the Buyer for the price at any time after the Seller has notified the Buyer that the Goods are ready for collection or (as the case may be) the Seller has tendered delivery of the Goods.

5.2 The Buyer shall pay the Price by the last day of the calendar month following delivery and the Seller shall be entitled to recover the Price, notwithstanding that delivery might not have taken place and the property in the Goods has not passed to the Buyer. The time of payment of the Price shall be of the essence of the Contract. Receipt for payment will be issued only upon request.

5.3 All amounts due under these Conditions shall be paid in full without any deduction or withholding and the Buyer shall not be entitled to assert any credit set-off or counterclaim against the Seller in order to justify withholding payment of any such amount in whole or in part.

5.4 If the Buyer fails to make any payment on the due date then, without prejudice to any other right or remedy available to the Seller, the Seller shall be entitled to:

5.4.1 cancel the Contract or suspend any further deliveries to the Buyer;

5.4.2 appropriate any payment made by the Buyer to such of the Goods or the Services (or the goods or services supplied under any other contract between the Buyer and the Seller) as the Seller may think fit (notwithstanding any purported appropriation by the Buyer); and

5.4.3 charge the Buyer interest from the due date up to the date of actual payment in full (both before and after any judgement) on the amount unpaid, at the rate of 4 per cent per annum above Barclays Bank base rate from time to time. Such interest shall accrue on a daily basis and be compounded quarterly.

6. Delivery

6.1 Delivery of the Goods shall be made by the Buyer collecting the Goods at the Seller's premises at any time after the Seller has notified the Buyer that the Goods are ready for collection on payment of the collection charge then specified in the Seller's price list or, if some other place for delivery is agreed by the Seller, the Seller delivery the Goods to that place.

6.2 In the event that the Seller is to deliver the Goods other than by making the same available for collection at its producing works, the method of carriage shall, unless otherwise agreed in Writing, be at the discretion of the Seller. Any transport or freight arranged or undertaken by the Seller shall be arranged or undertaken as agent for the Buyer and the Seller shall have no liability for any loss or damage to the Goods after the same have left the Seller's premises. The Seller may supply the Goods from any of its producing works.

6.3 The Seller shall only be obliged to deliver the Goods to a safe and suitable site at the place of delivery such as an area of hard standing. The Seller shall decide in its absolute discretion upon the safety and suitability of any such site.

6.4 The Seller reserves the right to charge to the Buyer any costs, charges or expenses incurred by the Seller as a result of vehicle detention or demurrage of ships in consequence of any act or omission of the Buyer, its employees or agents, or as a result of special requirements or stipulations of the Buyer not provided for in the Contract.

6.5 Any dates quoted for delivery of the Goods are approximate only and the Seller shall not be liable for any delay in delivery of the Goods whatsoever caused. Time for delivery shall not be of the essence of the Contract. The Goods may be delivered by the Seller in advance of the quoted delivery date upon giving reasonable notice to the Buyer.

6.6 Where the Goods are to be delivered in instalment, each delivery shall constitute a separate contract and failure by the Seller to deliver any one or more of the instalments in accordance with these Conditions or any claim by the Buyer in respect of any one or more instalments shall not entitle the Buyer to treat the Contract as a whole as repudiated.

6.7 If the seller fails to deliver the Goods (or any instalment) for any reason other than any cause beyond the Seller's reasonable control or the Buyer's fault, and the Seller is accordingly liable to the Buyer, the Seller's liability shall be limited to the excess (if any) of the cost to the Buyer (in the cheapest available market) of similar goods to replace those not delivered over the Price.

6.8 If the Buyer fails to take delivery of the Goods within 7 days of notification that the Goods are ready for collection or fails to give the Seller adequate delivery instructions at the time stated for delivery (otherwise than by reason of any cause beyond the Buyer's reasonable control or by reason of the Seller's fault) then, without prejudice to any other right or remedy available to the Seller, the Seller may:

6.8.1 deliver the Goods to the Buyer's address on the Buyer's order; or

6.8.2 store the Goods until actual delivery and charge the Buyer for the reasonable costs (including insurance) of storage; or

6.8.3 sell the Goods at the best price readily obtainable and (after deducting all reasonable storage and selling expenses) charge the Buyer for any shortfall below the price under the Contract.

7. Risk and Property

7.1 Risk of damage to or loss of the Goods shall pass to the Buyer:-

7.1.1 in the case of the Goods to be delivered at the Seller's premises, at the time when the Seller notifies the Buyer that the goods are available for collection; or

7.1.2 in the case of Goods to be delivered otherwise than at the Seller's premises, after the time the Goods have left the Seller's premises.

7.2 Notwithstanding delivery and the passing of risk in the Goods, or any other provision of these Conditions, the property in the Goods shall not pass to the Buyer until the Seller has received in cash or cleared funds payment in full of the Price and the price of all other goods and services agreed to be supplied by the Seller to the Buyer for which payment is then due.

7.3 Until such time as the property in the Goods passes to the Buyer, the Buyer shall hold the Goods as the Seller's fiduciary agent and bailee, and shall keep the Goods separate from those of the Buyer and third parties and properly stored and protected and insured and identified as the Seller's property, but shall be entitled to resell or use the Goods in the ordinary course of its business.

7.4 Until such time as the Property in the Goods passes to the Buyer (and provided the Goods are still in existence and have not been resold), the Seller shall be entitled at any time to require the Buyer to deliver up the Goods to the Seller and, if the Buyer fails to do so forthwith, to enter upon any premises of the Buyer or any third party where the Goods are stored and repossess the Goods.

7.5 The Buyer shall not be entitled to pledge or in any way charge by way of security for any indebtedness any of the Goods without any other warranty, condition or guarantee. If the Buyer does so all moneys owing by the Buyer to the Seller shall (without prejudice to any other right or remedy of the Seller) forthwith become due and payable.

7.6 The Seller shall have a first and paramount lien over any goods or property of the Buyer in its possession for all sums due and payable to the Seller.

7.7 Risk of damage to or loss of any free issue material supplied by the Buyer to the Seller shall remain at all time with the Seller who shall bear full responsibility for insuring or otherwise safeguarding such material.

8. Warranties and Liability

8.1 Subject to the conditions set out below the Seller warrants that the Goods will correspond with the Specification at the time of delivery.

8.2 The above warranty is given by the Seller subject to the following conditions:

8.2.1 the Seller shall be under no liability in respect of any defect in the Goods arising from any Specification supplied by the Buyer;

8.2.2 the Seller shall be under no liability in respect of any defect arising from fair wear and tear, wilful damage, negligence, improper or unsuitable storage conditions, abnormal working conditions, failure to follow the Seller's instructions (whether oral or in writing), misuse or alteration of the Goods without the Seller's approval;

8.2.3 the Seller shall be under no liability under the above warranty if the Seller has received payment in full of the total Price has not been paid by the due date for payment;

8.2.4 the above warranty does not extend to goods or materials not manufactured by the Seller, in respect of which the Buyer shall only be entitled to the benefit of any such warranty or guarantee as is given by the manufacturer to the Seller.

8.3 Subject as expressly provided in these Conditions all warranties, conditions or other terms implied by statute or common law are excluded to the fullest extent permitted by law.

8.4 Any claim by the Buyer which is based on any failure of the Goods to correspond with the Specification shall (whether or not delivery is refused by the Buyer) be notified to the Seller within 7 days from the date of delivery or (where the defect or failure was not apparent on reasonable inspection) within a reasonable time after discovery of the defect or failure and in any event within 30 days of delivery. If delivery is not refused, and the Buyer does not notify the Seller accordingly, the Buyer shall be deemed to have accepted the Goods and the Seller shall have no liability for such defect or failure, and the Buyer shall be bound to pay the Price as if the Goods had been delivered in accordance with the Contract.

8.5 Where any valid claim in respect of any of the Goods which is based on any defect in quality or condition thereof or their failure to meet the Specification is notified to the Seller in accordance with these conditions the Buyer shall give the Seller a reasonable opportunity to inspect the Goods prior to use or processing. The Seller shall be entitled to replace the Goods (or the part in question) free of charge or, at the Seller's sole discretion, refund to the Buyer the Price (or a proportionate part of the price), but the Seller shall have no further liability to the Buyer.

8.6 Except in respect of death or personal injury caused by the Seller's negligence, the Seller shall not be liable to the Buyer by reason of any implied warranty, condition or other term, or any duty at common law, or under the express terms of the contract, for any indirect, special or consequential loss or damage (whether for loss of profit or otherwise), cost, expenses or other claims for compensation whatsoever (whether caused by the negligence of the Seller, its employees or agents or otherwise) which arise out of or in connection with the supply of the Goods or their use or resale by the Buyer, and the entire liability of the Seller under or in connection with the contract shall not exceed the Price, except as expressly provided in these Conditions.

8.7 The Buyer acknowledges and accepts that it does not rely on, and shall have no remedy in respect of, any statement, representation, warranty or understanding (whether negligently or innocently made) of any person (whether party to the Contract or not) other than as expressly set out in these Conditions as a warranty. Nothing in this clause shall, however, operate to limit or exclude any liability for fraud.

8.8 The Seller shall not be liable to the Buyer or be deemed to be in breach of the Contract by reason of any delay in performing, or any failure to perform, any of the Seller's obligations in relation to the Goods, if the delay or failure was due to any cause beyond the Seller's reasonable control. Without prejudice to the generality of the foregoing, the following shall be regarded as causes beyond the Seller's reasonable control:

8.8.1 Act of God, explosion, flood, tempest, fire or accident;

8.8.2 war or threat of war, sabotage, insurrection, civil disturbance or requisition;

8.8.3 acts, restrictions, regulations, bye-laws, prohibitions or measures of any kind on the part of any governmental, parliamentary or local authority;

8.8.4 import or export regulations or embargoes;

8.8.5 strikes, lock-outs or other industrial actions or trade disputes (whether involving employees of the Seller or of a third party);

8.8.6 difficulties in obtaining raw material, labour, fuel, parts or machinery

8.8.7 power failure or breakdown in machinery or computer equipment;

8.8.8 failure of sub-contractors.

8.9 In the event that any of the circumstances referred to in 8.8 continue for a continuous period of 30 days and is continuing at the end of that time such an extent that substantial performance of the contract is prevented then either the Buyer or the Seller shall be entitled to give written notice terminating the contract with immediate effect. In the event that the contract is so terminated, the Seller shall be entitled to be paid in full for all work completed to the date of termination and a fair proportion for any work partially completed.

8.10 The Seller shall endeavour to ensure that its business systems are year 2000 compliant but does not make any representations nor give any warranties in respect of such compliance. The Seller shall not be liable to the Buyer or be deemed to be in breach of the Contract by reason of any delay in performing or any failure to perform any of the Seller's obligations in relation to the delivery of the Goods, if the delay or failure arises from or is connected to the changes arising before, during or after the year 2000

9. Insolvency of Buyer

9.1 This clause applies if:

9.1.1 the Buyer makes any voluntary arrangement with its creditors or (being an individual or firm) becomes bankrupt or (being a company) becomes subject to an administration order or goes into liquidation (otherwise than for the purposes of amalgamation or reconstruction); or

9.1.2 an embarrancer takes possession, or a receiver is appointed, of any of the property or assets of the Buyer; or

9.1.3 the Buyer ceases, or threatens to cease, to carry on business or (being a company) is wound up or dissolved (and no such step shall be taken by or on behalf of the Buyer without the Seller being given at least 5 business days' prior written notice thereof); or

9.1.4 steps are taken, proposed or threatened in respect of any of the events mentioned above or the Seller reasonably apprehends that any of the events mentioned above is about to occur in relation to the Buyer and notifies the Buyer accordingly.

9.2 If this clause applies then, without prejudice to any other right or remedy available to the Seller, the Seller shall be entitled to cancel the Contract or suspend any further deliveries under the Contract without liability to the Buyer, and if the Goods have been delivered but not paid for the Prices shall become immediately due and payable notwithstanding any previous agreement or arrangement to the contrary.

10. Export Terms

10.1 Where the Goods are supplied for export from the United Kingdom, the provisions of this clause 11 shall (subject to any special terms agreed in writing between the Buyer and the Seller) apply notwithstanding any other provision of these Conditions.

10.2 The Buyer shall be responsible for complying with any legislation or regulations governing the importation of the Goods into the country of destination and for the payment of any duties on them.

10.3 The Buyer shall be responsible for arranging for testing and inspection of the Goods at the Seller's premises before shipment. The Seller shall have no liability for any claim in respect of any defect in the Goods which would be apparent on inspection and which is made after shipment, or in respect of any damage during transit.

10.4 Unless otherwise agreed in Writing between the Buyer and the Seller, the Goods shall be delivered FOB the air or sea port of shipment and the Seller shall be under no obligation to give notice under section 32(3) of the Sale of Goods Act 1979.

10.5 Any marine insurance required to be effected by the Seller under the Contract shall, unless otherwise agreed in writing, be 10% above the invoice price and shall cover the interest from the commencement of transit to the destination named in the Contract as provided and contained in the Institute of London Underwriters ("the Institute") Cargo Clauses, the Institute's War Clauses and the Institute's Strikes, Riots and Civil Commotion Clauses, current at the time of shipment.

11. ECSC

11.1 The Order must show the final destination of the Goods and this destination may not be altered without the prior written consent of the Seller.

11.2 The goods are sold on the condition that they will not be re-sold by the Buyer or its buyers or sub-buyers for delivery in an unprocessed state outside the Territory of the ECSC. The Buyer shall be responsible for any breach of this condition and the Buyer shall also be responsible for ensuring that no goods sold to him by the Seller for delivery outside the ECSC shall be re-imported in an unprocessed state into the ECSC either by the Buyer or any of its buyers or sub-buyers. On receipt of a written demand from the Seller, the Buyer shall produce evidence of the ultimate destination of the Goods.

11.3 If the Buyer re-sells in an unprocessed state any goods bought from the Seller then, unless such resale is made from stock, the Buyer shall comply in respect of such resale with the requirement of High Authority Decision No. 30/53 (as amended from time to time) and also comply, as appropriate, with High Authority Decision No. 31/53 (as amended from time to time) or High Authority Decision No. 37/54 (as amended from time to time) and also comply with all other applicable requirements from time to time of the High Authority or of the European Commission. The references in this Condition of the High Authority are to the High Authority of the ECSC constituted by the Treaty of Paris of 18 April 1951.

12. General

12.1 Any notice required or permitted to be given by either party to the other under these Conditions shall be in Writing addressed to that other party at its registered office or principal place of business or such other address as may at the relevant time have been notified pursuant to this provision to the party giving notice.

12.2 No waiver by the Seller of any breach of the Contract by the Buyer shall be considered as a waiver of any subsequent breach of the same or any other provision.

12.3 If any provision of these Conditions is held by any competent authority to be invalid or unenforceable in whole or in part the validity of the other provisions of these conditions and the remainder of the provision in question shall not be affected.

12.4 The Contract shall be governed by the laws of England, and the Buyer agrees to submit to the exclusive jurisdiction of the English courts.



www.brc.ltd.uk

Scotland

BRC Newhouse

Block 14, Newhouse Industrial Estate,
Newhouse, Motherwell ML1 5SE
Tel: 01698 732343
Fax: 01698 833894
Email: sales@scotland.brc.ltd.uk

North West

BRC Oldham

Gould Street, Oldham,
Lancashire OL1 3LZ
Tel: 0161 620 1001
Fax: 0161 620 1660
Email: sales@northwest.brc.ltd.uk

Midlands

BRC Mansfield

79 Station Road, Sutton in Ashfield, Mansfield,
Nottinghamshire NG17 5FR
Tel: 01623 555111
Fax: 01623 440932
Email: sales@midlands.brc.ltd.uk

South East

BRC London

Unit 13, Kierbeck Business Complex,
North Woolwich Road, Silvertown, London E16 2BG
Tel: 020 7474 1800
Fax: 020 7474 8686
Email: sales@southeast.brc.ltd.uk

South West

BRC Plymouth

Unit C, Kingsley Close, East Way, Lee Mill Trading
Estate, Ivybridge, Plymouth, Devon PL21 9LL
Tel: 01752 894660
Fax: 01752 896761
Email: sales@southwest.brc.ltd.uk

North East

BRC Darlington

Skerne Works, Dodsworth Street, Albert Hill,
Darlington, County Durham DL1 2NG
Tel: 01325 381166
Fax: 01325 284124
Email: sales@northeast.brc.ltd.uk

North

BRC Barnsley

Whaley Road, Barugh, Barnsley,
South Yorkshire S75 1HT
Tel: 01226 730330
Fax: 01226 771797
Email: sales@north.brc.ltd.uk

Wales & West

BRC Newport

Corporation Road, Newport,
Gwent NP19 4RD
Tel: 01633 280816
Fax: 01633 283469
Email: sales@walesandwest.brc.ltd.uk

South

BRC Southampton

Belbins Business Park, Cupernham Lane,
Romsey, Hampshire SO51 7JF
Tel: 01794 521158
Fax: 01794 521154
Email: sales@south.brc.ltd.uk

Finance office

BRC Wokingham

11 Mulberry Business Park, Fishponds Road,
Wokingham, Berkshire RG41 2FH
Tel: 0118 977 3822
Fax: 0118 977 3913
Email: enquiries@wokingham.brc.ltd.uk

Other BRC companies

BRC Special Products

Carver Road, Astonfields Industrial Estate,
Stafford ST16 3BP
Tel: 01785 222288
Fax: 01785 240029
Email: stafford.enquiries@brc-special-products.co.uk
Website: www.brc-special-products.co.uk

Weldgrip Geotechnical

Unit 19, Redbrook Business Park, Wilthorpe Road,
Barnsley, South Yorkshire S75 1JN
Tel: 01226 280567
Fax: 01226 731563
Email: tech@weldgrip.com
Website: www.weldgrip.com